

Legacy Schneider Electric Solid-State Relays

Catalog
2017



Schneider
Electric™

- Series Overview3
- 861 Relays4
- 861H Relays7
- SSRDIN Relays10
- 6000 Series Relays13
- Accessories for 6000 Series Relays17
- 70S2 Series Relays19
- Application Data24
- Selection Guide29
- Website Guide30

Legacy Schneider Electric™ solid-state relays offer a number of advantages over electromechanical relays, including longer life cycles, less energy consumption and reduced maintenance costs, depending on the application.

Key Features

- 100% solid-state design
- Modern appearance and advanced technology
- Industry first design (861 and 861H series)
- Several styles to fit multiple applications

Series	Defining Feature	Style	Internal Heat Sink	Contact Configuration	Output Current Range (A)	Input Voltage Range	Output Voltage Range	Page
861	Slim 17.5 mm profile	Slim DIN and panel mount	Yes	SPST-NO SPST-NC	8–15	3–32 Vdc 90–280 Vac	3–150 Vdc 24–480 Vac	6
861H	Class 1, Division 2 certified for use in hazardous locations	Slim DIN and panel mount	Yes	SPST-NO SPST-NC	8–15	3–32 Vdc 90–280 Vac	3–150 Vdc 24–480 Vac	9
SSRDIN	Integrated heat sink and high current switching capacity	DIN and panel mount	Yes	SPST-NO	10–45	4–32 Vdc 90–280 Vac	0–60 Vdc 24–660 Vac	12
6000	High current switching capacity in a small package	Hockey puck—panel mount	No	SPST-NO DPST-NO	10–75	3–32 Vdc 90–280 Vac	3–200 Vdc 24–480 Vac	15
70S2	Small package size	PCB and panel mount	No	SPST-NO	3–25	3–32 Vdc	3–60 Vdc 8–280 Vac	21



861 Relay



861H Relay



SSRDIN Relay



6000 Series Relays



70S2 Series Relays

Description

Legacy Solid-State Relays

861

SPST-NO, 8–15 A

SPST-NC, 10 A



861 Relay

Description

The 861 is the first complete solid-state relay without any moving parts, all in a slim 17.5 mm design.

Feature	Benefit
Solid-state circuitry	Involves no moving parts, which extends product life, increases reliability, and enables silent operation
Optically coupled circuit	Provides isolation between input and output circuits
Internal snubber	Helps protect the relay's internal circuit from high voltage transients
Internal heat sink	Provides factory-tested thermal management
Finger protected terminals (per IP20)	Help prevent an operator from touching live circuits
DIN and panel mounting	Mounts directly onto a DIN rail or panel, and provides flexibility to accommodate last-minute design changes

Switching Type	Switching Device (1)	Input Voltage Range	Output Voltage Range	Contact Configuration	Rated Output Current (A)	Standard Part Number
DC Switching	MOSFET	3.5–32 Vdc	3–50 Vdc	SPST-NO	15	861SSR115-DD
			3–150 Vdc	SPST-NO	8	861SSR208-DD
AC Random	Triac	3–32 Vdc	24–280 Vac	SPST-NO	8	861SSRA208-DC-2
			24–280 Vac	SPST-NC	8	861SSRA208-DC-4
			48–480 Vac	SPST-NO	8	861SSRA408-DC-2
			48–480 Vac	SPST-NO	8	861SSRA408-DC-4
	SCR	90–280 Vac	24–280 Vac	SPST-NO	8	861SSRA208-AC-2
			48–480 Vac	SPST-NO	8	861SSRA408-AC-2
			24–280 Vac	SPST-NO	10	861SSR210-DC-2
			24–280 Vac	SPST-NC	10	861SSR210-DC-4
			48–480 Vac	SPST-NO	10	861SSR410-DC-2
			48–480 Vac	SPST-NO	10	861SSR610-DC-2
AC Zero Cross	Triac	3–32 Vdc	24–280 Vac	SPST-NO	8	861SSRA208-DC-1
			48–480 Vac	SPST-NO	8	861SSRA408-DC-1
			24–280 Vac	SPST-NO	8	861SSRA208-AC-1
			48–480 Vac	SPST-NO	8	861SSRA408-AC-1
	SCR	90–280 Vac	24–280 Vac	SPST-NO	10	861SSR210-DC-1
			48–480 Vac	SPST-NO	10	861SSR410-DC-1
			48–600 Vac	SPST-NO	10	861SSR610-DC-1
			24–280 Vac	SPST-NO	10	861SSR210-AC-1
			48–480 Vac	SPST-NO	10	861SSR410-AC-1
			48–600 Vac	SPST-NO	10	861SSR610-AC-1

Part Number Explanation

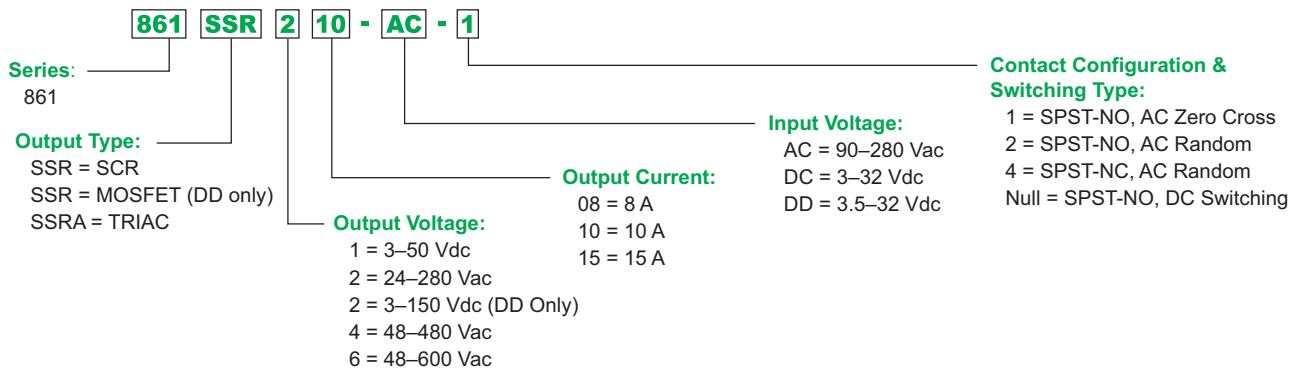

Legacy Solid-State Relays

861
SPST-NO, 8–15 A
SPST-NC, 10 A

Specifications (UL 508)

Part Number	861SSR***-DD	861SSRA***-DC*	861SSR***-DC*	861SSRA***-AC*	861SSR***-AC*
Input Characteristics					
Input Voltage Range	3.5–32 Vdc	3–32 Vdc		90–280 Vac	
Must Release Voltage	1 Vdc			10 Vac	
Nominal Input Impedance	Current regulator			16–25 kW	
Typical Input Current at 5 Vdc	12mA	16 mA; 12 mA (861SSR210-DC-4)		12mA	
Reverse Polarity Protection	Yes			N/A	
Output Characteristics					
Switching Device	MOSFET	Triac	SCR	Triac	SCR
Switching Type	DC Switching	AC Zero Cross; AC Random			
Contact Configuration	SPST-NO	SPST-NO; SPST-NC			
Output Voltage Range	3–50 Vdc; 3–150 Vdc	24–280 Vac; 48–480 Vac; 48–600 Vac			
Maximum Rate of Rise, Off-State Voltage (dv/dt)	N/A	250 V/us	500 V/us; 350 V/us (861SSR410, 861SSR610-DC-1); 200 V/us (861SSR210- DC-4, 861SSR610-DC-2)	250 V/us	500 V/us; 350 V/us (861SSR410); 250 V/us (861SSR610)
Current Ratings	Load rating: 8 A rms, 15 A rms	Load rating: 8 A (rms) Incandescent lamp rating: 5 A (rms) Motor load rating: 3 A (rms)	Load rating: 10 A (rms) Incandescent lamp rating: 8 A (rms) Motor load rating: 4.5 A (rms)	Load rating: 8 A (rms) Incandescent lamp rating: 5 A (rms) Motor load rating: 3 A (rms)	Load rating: 10 A (rms) Incandescent lamp rating: 8 A (rms) Motor load rating: 4.5 A (rms)
Minimum Load Current–Maintain On	20mA	150mA	50 mA	150mA	50 mA
Non-Repetitive Surge Current (1 cycle)	861SSR115-DD: 35 A; 861SSR208-DD: 50 A	200 A	500 A	200 A	500 A
Maximum RMS Overload Current (1 s)	861SSR115-DD: 17 A; 861SSR208-DD: 24 A	24 A			
Maximum Off-State Leakage Current	0.25 mA	10 mA (rms)			
Typical On-State Voltage Drop	N/A	1.25 Vac (rms)			
Maximum On-State Voltage Drop	0.5 Vdc	1.6 Vac (rms)			
Maximum On-State Resistance	40 mW	N/A			
Maximum Turn-On Time	5 ms	8.3 ms			
Maximum Turn-Off Time	5 ms	8.3 ms			
Maximum I ² T for Fusing	N/A	250 A ² sec	1250 A ² sec (861SSR210); 850 A ² sec (861SSR410); 600 A ² sec (861SSR610)	250 A ² sec	1250 A ² sec (861SSR210); 850 A ² sec (861SSR410); 600 A ² sec (861SSR610)
General Characteristics					
Electrical Life	N/A for solid-state relays				
Thermal Resistance (Junction–Case)	861SSR115-DD: 0.5 °C/W; 861SSR208-DD: 1.4 °C/W	2.00 °C/W	0.66 °C/W	2.00 °C/W	0.66 °C/W
Internal Heat Sink	4.0 °C/W				
Dielectric Strength (Input–Output)	2500 V (rms)	4000 V (rms)			
Dielectric Strength (Terminals–Chassis)	2500 V (rms)				
Operating Temperature Range	–30 to +80 °C (derating applies)				
Storage Temperature Range	–40 to +100 °C				
Weight	127.1 g (4.1 oz)				
Input Indication	Green LED				
Terminal Wire Capacity (Input and Output)	14 AWG (2.5 mm ²) maximum				
Terminal Screw Torque	7.1 lb-in (0.8 N•m) maximum				
Safety Cover	IP20				
Agency Approvals	CULus (File: E258297 CCN: NRNT, NRNT7), cURus (File: E258297 CCN: NRNT2, NRNT8), CSA (File: 40787 Class: 3211 04); CE; RoHS				

*Dimensions,
Wiring Diagram,
Derating Curves*

Legacy Solid-State Relays

861
SPST-NO, 8–15 A
SPST-NC, 10 A

Dimensions: in. (mm)

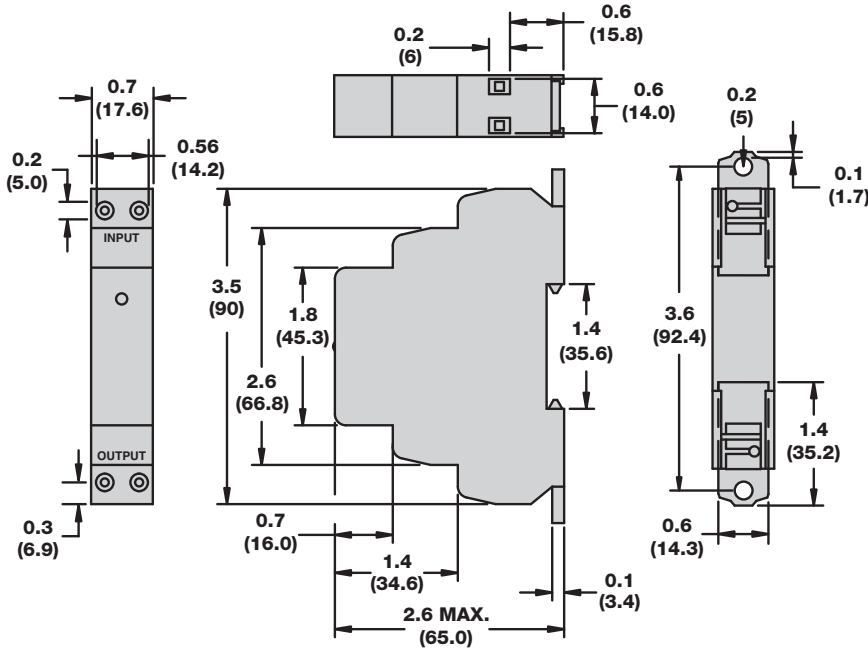

Wiring Diagram

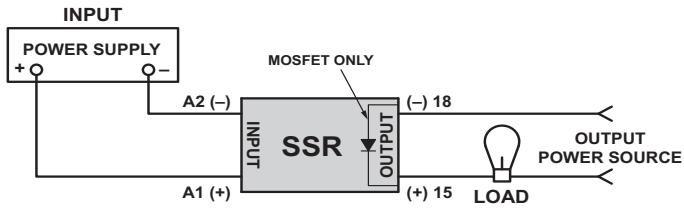

Derating Curves

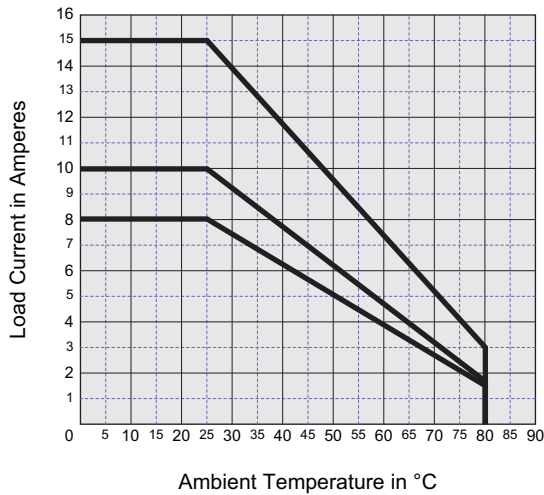

Note: A minimum spacing of 17.5 mm (0.7 in.) is required between adjacent 861 relays in order to achieve the maximum ratings.

Description

Legacy Solid-State Relays

861H
SPST-NO, 8–15 A



Class I, Division 2 certification for use in hazardous locations. (Temperature code: T5)



861H Relay

Description

The 861H is a patented solid-state relay, in a slim 17.5 mm design, approved for use in hazardous locations.

Feature	Benefit
Class I, Division 2 certification (1)	UL certified for Class I Division 2 Hazardous Locations per ISA 12.12
Solid-state circuitry	Involves no moving parts, which extends product life, increases reliability, and enables silent operation
Optically coupled circuit	Provides isolation between input and output circuits
Internal snubber	Helps protect the relay's internal circuit from high voltage transients
Internal heat sink	Provides factory-tested thermal management
Finger protected terminals (per IP20)	Help prevent an operator from touching live circuits
DIN and panel mounting	Mounts directly onto a DIN rail or panel, and provides flexibility to accommodate last-minute design changes

(1) See page 29 for more information on Class I, Division 2.

Switching Type	Switching Device (1)	Input Voltage Range	Output Voltage Range	Contact Configuration	Rated Output Current (A)	Standard Part Number
DC Switching	MOSFET	3.5–32 Vdc	3–50 Vdc	SPST-NO	15	861HSSR115-DD
			3–150 Vdc	SPST-NO	8	861HSSR208-DD
AC Random	Triac	3–32 Vdc	24–280 Vac	SPST-NO	8	861HSSRA208-DC-2
			48–480 Vac	SPST-NO	8	861HSSRA208-DC-4
			24–280 Vac	SPST-NO	8	861HSSRA408-DC-2
		90–280 Vac	24–280 Vac	SPST-NO	8	861HSSRA208-AC-2
			48–480 Vac	SPST-NO	8	861HSSRA408-AC-2
			48–600 Vac	SPST-NO	10	861HSSR610-AC-2
	SCR	3–32 Vdc	24–280 Vac	SPST-NO	10	861HSSR210-DC-4
			48–480 Vac	SPST-NO	10	861HSSR410-DC-2
			48–600 Vac	SPST-NO	10	861HSSR610-DC-2
		90–280 Vac	24–280 Vac	SPST-NO	10	861HSSR210-AC-2
			48–480 Vac	SPST-NO	10	861HSSR410-AC-2
			48–600 Vac	SPST-NO	10	861HSSR610-AC-2
AC Zero Cross	Triac	3–32 Vdc	24–280 Vac	SPST-NO	8	861HSSRA208-DC-1
			48–480 Vac	SPST-NO	8	861HSSRA408-DC-1
			24–280 Vac	SPST-NO	8	861HSSRA208-AC-1
		90–280 Vac	24–280 Vac	SPST-NO	8	861HSSRA408-AC-1
			48–480 Vac	SPST-NO	8	861HSSRA408-AC-1
			48–600 Vac	SPST-NO	10	861HSSR210-DC-1
	SCR	3–32 Vdc	24–280 Vac	SPST-NO	10	861HSSR410-DC-1
			48–480 Vac	SPST-NO	10	861HSSR610-DC-1
			48–600 Vac	SPST-NO	10	861HSSR610-DC-1
		90–280 Vac	24–280 Vac	SPST-NO	10	861HSSR210-AC-1
			48–480 Vac	SPST-NO	10	861HSSR410-AC-1
			48–600 Vac	SPST-NO	10	861HSSR610-AC-1

Part Number Explanation

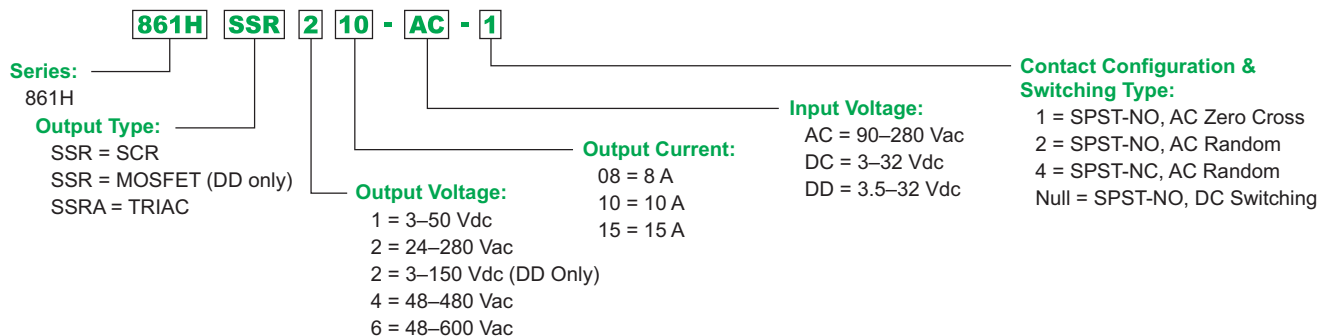

Specifications (UL 508)

Part Number	861HSSR***-DD	861HSSRA***-DC-	861HSSR***-DC-	861HSSRA***-AC-	861SSR***-AC-
Input Characteristics					
Input Voltage Range	3.5–32 Vdc	3–32 Vdc		90–280 Vac	
Must Release Voltage	1 Vdc			10 Vac	
Nominal Input Impedance	Current regulator			16–25 kΩ	
Typical Input Current at 5 Vdc	12 mA	16 mA (12 mA for 861HSSR210-DC-4)		12 mA	
Reverse Polarity Protection	Yes			N/A	
Output Characteristics					
Switching Device	MOSFET	Triac	SCR	Triac	SCR
Switching Type	DC Switching		AC Zero Cross; AC Random		
Contact Configuration	SPST-NO		SPST-NO, SPST-NC		
Output Voltage Range	3–50 Vdc; 3–150 Vdc	24–480 Vac; 48–480 Vac; 48–600 Vac			
Maximum Rate of Rise Off-State Voltage (dv/dt)	N/A	250 V/us	500 V/us, 350 V/us (861HSSR410, 861HSSR610-DC-1), 200 V/us (861HSSR210-DC-4, 861HSSR610-DC-2)	250 V/us	500 V/us, 350 V/us (861HSSR410), 250 V/us (861HSSR610)
Current Ratings	Load rating	8 A (rms), 15 A (rms)	8 A (rms)	10 A (rms)	8 A (rms), 10 A (rms)
	Incandescent lamp rating	N/A	5 A (rms)	8 A (rms)	5 A (rms), 8 A (rms)
	Motor load rating	N/A	3 A (rms)	4.5 A (rms)	3 A (rms), 4.5 A (rms)
Minimum Load Current–Maintain On	20 mA	150 mA	50 mA	150 mA	50 mA
Non-Repetitive Surge Current (1 cycle)	861HSSR115-DD: 35 A; 861HSSR208-DD: 50 A	200 A	500 A	200 A	500 A
Maximum RMS Overload Current (1 s)	861HSSR115-DD: 17 A; 861HSSR208-DD: 24 A	24 A			
Maximum Off-State Leakage Current	0.25 mA	10 mA (rms)			
Typical On-State Voltage Drop	N/A	1.25 Vac (rms)			
Maximum On-State Voltage Drop	0.5 Vdc	1.6 Vac (rms)			
Maximum On-State Resistance	40 mΩ	N/A			
Maximum Turn-On Time	5 ms	8.3 ms			
Maximum Turn-Off Time	5 ms	8.3 ms			
Maximum I ² T for Fusing	N/A	250 A ² sec	1250 A ² sec (861HSSR210); 850 A ² sec (861HSSR410); 600 A ² sec (861HSSR610)	250 A ² sec	1250 A ² sec (861HSSR210); 850 A ² sec (861HSSR410); 600 A ² sec (861HSSR610)
General Characteristics					
Electrical Life	N/A for solid-state relays				
Thermal Resistance (Junction–Case)	861HSSR115-DD: 0.5 °C/W; 861HSSR208-DD: 1.4 °C/W	2.00 °C/W	0.66 °C/W	2.00 °C/W	0.66 °C/W
Internal Heat Sink	4.0 °C/W				
Dielectric Strength	Input–Output	2500 V (rms)	4000 V (rms)		
	Terminals–Chassis	2500 V (rms)			
Operating Temperature Range	–30 to +80 °C (derating applies)				
Storage Temperature Range	–40 to +100 °C				
Weight	127.1 g (4.1 oz)				
Input Indication	Green LED				
Terminal Wire Capacity (Input and Output)	14 AWG (2.5 mm ²) maximum				
Terminal Screw Torque	7.1 lb-in (0.8 N•m) maximum				
Safety Cover	IP20				
Agency Approvals	UL certified for Class I, Division 2 Hazardous Locations; per ISA 12.12.1, cURus (File: E317746 CCN: NQMJ2, NQMJ8), CSA (File: 40787 Class: 3211 04); CE; RoHS				

Dimensions: in. (mm)

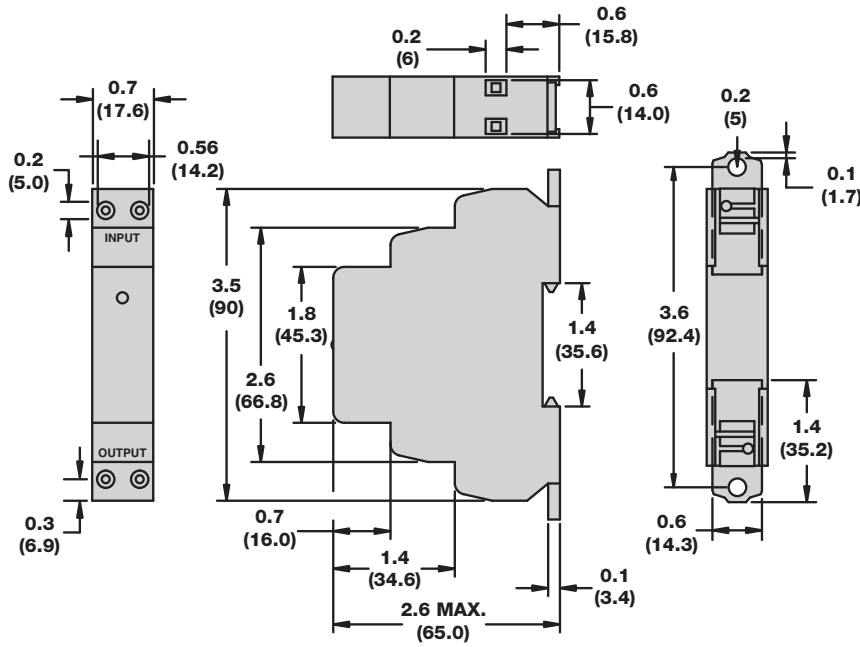

Wiring Diagram

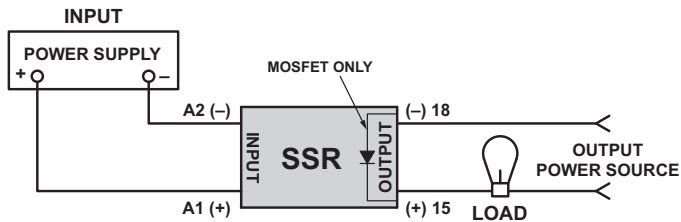

Derating Curves

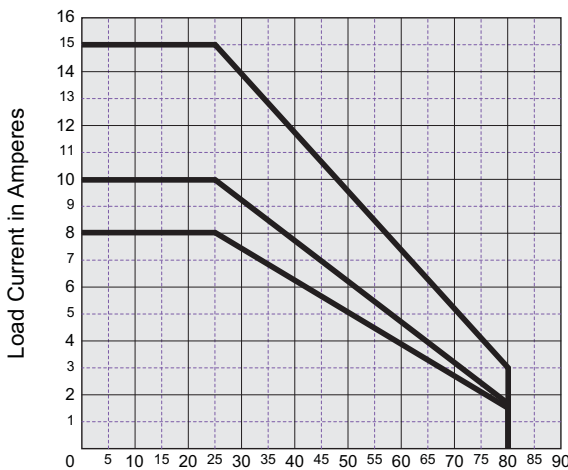

Note: A minimum spacing of 17.5 mm (0.7 in.) is required between adjacent 861 relays in order to achieve the maximum ratings.

Legacy Solid-State Relays

SSRDIN

SPST-NO, 10–45 A



SSRDIN Relay

Description

The SSRDIN relays offer a complete solid-state package that is an energy-efficient, current switching alternative to standard electromechanical relays. Advantages include longer life cycles, less energy consumption, and reduced maintenance costs.

Feature	Benefit
Solid-state circuitry	Involves no moving parts
Optically coupled circuit	Provides isolation between input and output circuits
Internal snubber	Helps protect the relay's internal circuit from high voltage transients
Internal heat sink	Provides factory tested thermal management
Integrated chassis ground	Simplifies system wiring
Finger protected terminals	Help prevent an operator from touching live circuits
DIN and panel mounting	Increases functionality and ease of use, and fits a variety of applications

Switching Type	Switching Device (1)	Input Voltage Range	Output Voltage Range	Contact Configuration	Rated Output Current (A)	Standard Part Number	
DC Switching	MOSFET	4–32 Vdc	0–60 Vdc	SPST-NO	10	SSR310DIN-DC22	
					20	SSR320DIN-DC22	
					30	SSR330DIN-DC22	
AC Zero Cross	SCR	4–32 Vdc	24–280 Vac	SPST-NO	10	SSR210DIN-DC22	
					20	SSR220DIN-DC22	
					30	SSR230DIN-DC22	
			3–32 Vdc	24–280 Vac	SPST-NO	45	SSR245DIN-DC45
						10	SSR610DIN-DC22
						20	SSR620DIN-DC22
		4–32 Vdc	48–660 Vac	SPST-NO	30	SSR630DIN-DC22	
					45	SSR645DIN-DC45	
					65	SSR665DIN-AC45	
			90–280 Vac	24–280 Vac	SPST-NO	10	SSR210DIN-AC22
						20	SSR220DIN-AC22
						30	SSR230DIN-AC22
90–140 Vac	24–280 Vac	SPST-NO		45	SSR245DIN-AC45		
				10	SSR610DIN-AC22		
				20	SSR620DIN-AC22		
90–280 Vac	48–660 Vac	SPST-NO	30	SSR630DIN-AC22			
			45	SSR645DIN-AC45			
			65	SSR665DIN-AC45			

(1) See page 28 for definitions of the different switching devices.

Part Number Explanation

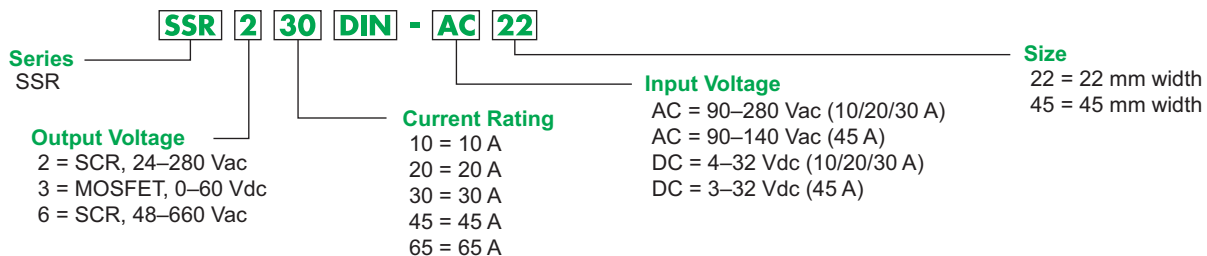

Specifications (UL 508)

Part Number	SSR2**DIN-DC**	SSR3**DIN-DC22	SSR6**DIN-DC**	SSR2**DIN-AC**	SSR6**DIN-AC**
Input Characteristics					
Input Voltage Range	10/20/30 A: 4–32 Vdc; 45/65 A: 3–32 Vdc			10/20/30 A: 90–280 Vac; 45/65 A: 90–140 Vac	
Maximum Turn-On Voltage	4 Vdc			90 Vrms	
Minimum Turn-Off Voltage	1 Vdc			10 Vrms	
Typical Input Current	8–12 mA	9–11 mA	8–12 mA	2–4 mA	
Output Characteristics					
Output Type	SCR	MOSFET	SCR		
Switching Type	AC Zero Cross	DC Switching	AC Zero Cross		
Output Voltage	24–280 Vac	0–60 Vdc	48–660 Vac	24–280 Vac	48–660 Vac
Load Current Range	10–45 A	10–30 A	10–45 A		
Transient Overvoltage	600 Vpk	N/A	1200 Vpk	600 Vpk	1200 Vpk
Maximum Surge Current	10 A: 120 Apk; 20 A: 250 Apk; 30/45 A: 625 Apk (at 16.6 ms)	10 A: 30 Apk; 20 A: 60 Apk; 30 A: 90 Apk (at 10 ms)	625 Apk (at 16.6 ms)	10 A: 120 Apk; 20 A: 250 Apk; 30/45 A: 625 Apk (at 16.6 ms)	625 Apk (at 16.6 ms)
Maximum On-State Voltage Drop at Rated Current	1.6 Vpk	10 A: 0.2 Vpk; 20 A: 0.4 Vpk; 30 A: 0.5 Vpk	1.6 Vpk	1.6 Vpk	1.6 Vpk
Maximum I ² t For Fusing, (8.3 ms)	10 A: 60 A ² sec; 20 A: 260 A ² sec; 30/45 A: 1620 A ² sec	N/A	1620 A ² sec	10 A: 60 A ² sec; 20 A: 260 A ² sec; 30/45 A: 1620 A ² sec	1620 A ² sec
Maximum Off-State Leakage Current at Rated Voltage	10 mA	0.1 mA	1 mA	10 mA	1 mA
Maximum Rate of Rise Off-State Voltage (dv/dt)	500 V/us	N/A	500 V/us		
Maximum Response Time (On and Off)	1/2 cycle	1.0 ms	1/2 cycle		
Maximum On-State Resistance	N/A	10 A: 20 mΩ; 20 A: 18 mΩ; 30 A: 16 mΩ	N/A		
General Characteristics					
Electrical Life	N/A for solid-state relays				
Operating Temperature Range	–40 to +80 °C (derating applies)				
Storage Temperature Range	–40 to +125 °C				
Weight	10/20/30 A: 272 g (9.6 oz); 45/65 A: 482 g (17 oz)				
Input Indication	Green LED				
Encapsulation	Thermally conductive epoxy				
Input Terminal Screw Torque	10/20/30 A: 5.0–6.0 lb-in (0.6–0.7 N-m); 45/65 A: 5.0–6.0 lb-in (0.6–0.7 N-m)				
Output Terminal Screw Torque	10/20/30 A: 5.0–6.0 lb-in (0.6–0.7 N-m); 45/65 A: 10.0–15.0 lb-in (1.1–1.7 N-m)				
Mount Type	DIN rail and panel mount				
Agency Approvals	cURus (File: E258297 CCN: NRNT2, NRNT8), CSA (168986 Class 3211 07), SCR output only; CE (per IEC 60950 and 61000); RoHS				

*Dimensions,
Wiring Diagram,
Derating Curves*

Legacy Solid-State Relays
SSRDIN
SPST-NO, 10–45 A

Dimensions: in. (mm)

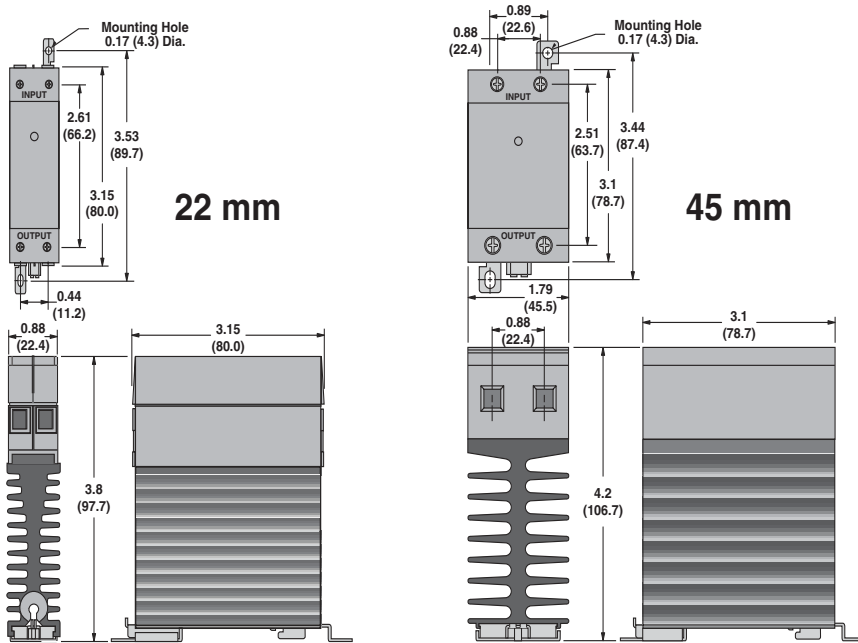

Wiring Diagram

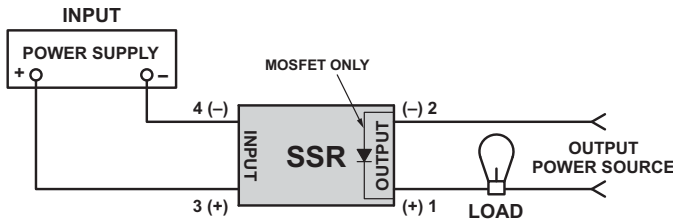

	22 mm		45 mm	
	input	output	input	output
a	6 mm ² AWG 10	4 mm ² AWG 12	10 mm ² AWG 8	

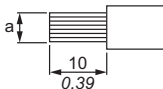

Derating Curves

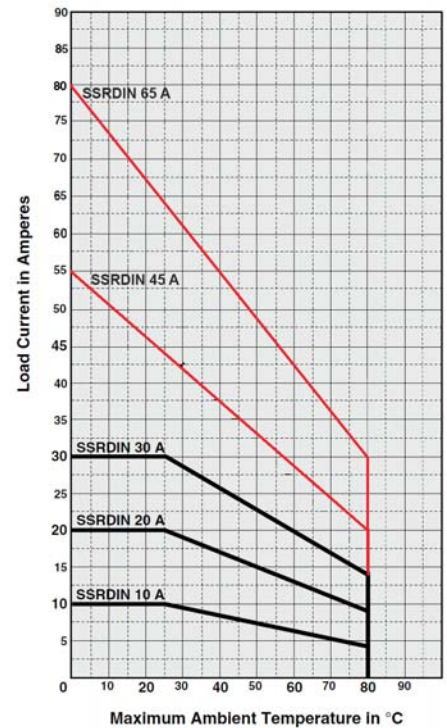

Description

Legacy Solid-State Relays

6000

SPST-NO, 10–75 A

DPST-NO, 10–25 A



6000 Series Relays

Description

The 6000 Series solid-state relays offer an energy-efficient current switching alternative to standard electromechanical relays. Advantages include longer life cycles, less energy consumption, and reduced maintenance costs.

Feature	Benefit
Solid-state circuitry	Involves no moving parts
Optically coupled circuit	Provides isolation between input and output circuits
Internal snubber	Helps protect the relay's internal circuit from high voltage transients
Finger protected terminals	Help prevent an operator from touching live circuits

Switching Type	Switching Device (1)	Input Voltage Range	Output Voltage Range	Contact Configuration	Rated Output Current (A)	Standard Part Number
DC Switching	MOSFET	3.5–32 Vdc	3–200 Vdc	SPST-NO	12	6312AXXMDS-DC3
					25	6325AXXMDS-DC3
					40	6340AXXMDS-DC3
AC Zero Cross	SCR	3–32 Vdc	24–280 Vac	SPST-NO	10	6210AXXSZS-DC3
					25	6225AXXSZS-DC3
					40	6240AXXSZS-DC3
			48–480 Vac	SPST-NO	50	6250AXXSZS-DC3
					75	6275AXXSZS-DC3
					25	6425AXXSZS-DC3
	90–280 Vac	24–280 Vac	SPST-NO	40	6440AXXSZS-DC3	
				50	6450AXXSZS-DC3	
				75	6475AXXSZS-DC3	
		48–480 Vac	SPST-NO	10	6210AXXSZS-AC90	
				25	6225AXXSZS-AC90	
				40	6240AXXSZS-AC90	
TRIAK (2)	3–32 Vdc	24–280 Vac	DPST-NO	10	6210BXXTZB-DC3	
				25	6425AXXTZB-DC3	
				25	6425BXXTZB-DC3	
		48–480 Vac	DPST-NO	10	6210BXXTZB-DC3	
				25	6425AXXTZB-DC3	
				25	6425BXXTZB-DC3	

(1) See page 28 for definitions of the different switching devices.

(2) Blade terminals.

Part Number Explanation

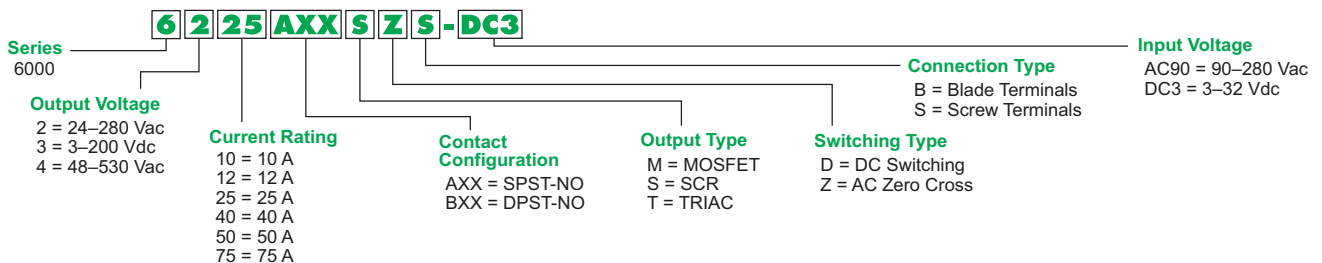

Legacy Solid-State Relays

6000

SPST-NO, 10–75 A

DPST-NO, 10–25 A

Specifications (UL 508)

Part Number	62**AXXSZS-AC90	64**AXXSZS-AC90	62**AXXSZS-DC3	64**AXXSZS-DC3
Input Characteristics				
Control Voltage Range	90–280 Vac (rms)		3–32 Vdc	4–32 Vdc
Maximum Turn-On Voltage	90 Vac (rms)		3 Vdc	4 Vdc
Minimum Turn-Off Voltage	10 Vac (rms)		1 Vdc	
Nominal Input Impedance	60 kΩ		N/A (active current limiter)	
Typical Input Current	2 mA at 120 V (rms); 4 mA at 240 V (rms)		10 mA at 12 Vdc	15 mA DC
Output Characteristics				
Switching Device	SCR			
Switching Type	AC Zero Cross			
Contact Configuration	SPST-NO			
Output Current Range	10–75 A	10–25 A	10–50 A	25–50 A
Output Voltage Range (47–63 Hz)	24–280 Vac (rms)	48–530 Vac (rms)	24–280 Vac (rms)	48–530 Vac (rms)
Transient Overvoltage	600 Vpk	1200 Vpk	600 Vpk	1200 Vpk
Maximum Off-State Leakage Current at Rated Voltage	10 mA (rms)		1 mA (rms)	
Minimum Off-State dv/dt at Maximum Rated Voltage	500 V/us			
Minimum Load Current	40 mA (rms)		150 mA (rms)	
Maximum Surge Current (16.6 ms)	10 A: 120 Apk 25 A: 250 Apk 40/50 A: 625 Apk 75 A: 1000 Apk	10 A: 140 Apk 25 A: 250 Apk	10 A: 120 Apk 25 A: 250 Apk 40/50 A: 625 Apk	25 A: 250 Apk 50 A: 625 Apk
Maximum On-State Voltage Drop at Rated Current	1.6 V (rms)	1.7 V (rms)	1.6 V (rms)	
Maximum I ² T for Fusing (8.3 ms)	10 A: 60 A ² sec 25 A: 260 A ² sec 40/50A: 1620 A ² sec 75A: 4150 A ² sec	10 A: 81 A ² sec 25 A: 260 A ² sec	10 A: 60 A ² sec 25 A: 260 A ² sec 40/50 A: 1620 A ² sec	25 A: 260 A ² sec 50 A: 1620 A ² sec
Minimum Power Factor (with Maximum Load)	0.5			
General Characteristics				
Electrical Life	N/A for solid-state relays			
Maximum Turn-On Time	10 ms		1/2 Cycle	
Maximum Turn-Off Time	40 ms		1/2 Cycle	
Thermal Resistance (Junction–Case)	10 A: 1.48 °C/W; 25 A: 1.02 °C/W; 40/50A: 0.63 °C/W; 75 A: 0.31 °C/W			
Dielectric Strength, Input/Output/Base (50/60 Hz)	4000 Vac (rms)			
Minimum Insulation Resistance (at 500 Vdc)	1E+9 Ω			
Maximum Capacitance (Input/Output)	8 pF			
Ambient Operating Temperature Range	–40 to +80 °C (derating applies)			
Ambient Storage Temperature Range	–40 to +125 °C			
Weight (typical)	86.5 g (3 oz)			
Input Indication	Green LED			
Encapsulation	Thermally conductive epoxy			
Terminals	Screw and saddle clamps furnished, unmounted			
Maximum Torque for Terminal Screws (screws dry without grease)	Input Terminals: 10 lb-in Output Terminals: 20 lb-in			
Safety Cover	Yes			
Wire Clamp Plates	Yes			
Agency Approvals	UL Recognized (File: E258297, CCN: NRNT2, NRNT8), CSA (File: 168986, Class: 3211-07), CE, RoHS			

Legacy Solid-State Relays

6000

SPST-NO, 10–75 A

DPST-NO, 10–25 A

Specifications (UL 508)

Part Number	6***XXTZB-DC3	63**AXXMDS-DC3
Input Characteristics		
Control Voltage Range	3–32 Vdc	3.5–32 Vdc
Maximum Turn-On Voltage	3 Vdc	3.5 Vdc
Minimum Turn-Off Voltage	1 Vdc	
Nominal Input Impedance	Active current limiter	1 kΩ
Typical Input Current	25 A: 16 mA 10 A: 2 mA	10 mA
Output Characteristics		
Switching Device	TRIAC	MOSFET
Switching Type	AC Zero Cross	DC Switching
Contact Configuration	SPST-NO, DPST-NO	SPST-NO
Output Current Range	10–25 A	12–40 A
Output Voltage Range	10 A: 24–280 Vac 25 A: 48–480 Vac	3–200 Vdc
Transient Overvoltage	600 Vpk	200 Vpk
Maximum Off-State Leakage Current at Rated Voltage	10 mA	< 1 mA
Minimum Off-State dv/dt at Maximum Rated Voltage	250 V/us	N/A
Minimum Load Current–Maintain	80 mA	N/A
Maximum Surge Current (16.6 ms)	250 A	12 A: 27 A 25 A: 50 A 40 A: 90 A
Maximum On-State Voltage Drop at Rated Current	1.6 Vac (rms)	2.8 Vdc (at 40 A load)
Maximum I ² T for Fusing (8.3 ms)	200 A ² s	N/A
Minimum Power Factor (with Maximum Load)	0.5	0.95
General Characteristics		
Electrical Life	N/A for solid-state relays	
Maximum Turn-On Time	1/2 cycle	300 us
Maximum Turn-Off Time	1/2 cycle	1 ms
Thermal Resistance (Junction–Case)	1.2 °C/W	1.06 °C/W
Dielectric Strength, Input/Output/Base (50/60 Hz)	4000 Vac (rms)	2500 Vac (rms)
Minimum Insulation Resistance (at 500 Vdc)	1E+9 Ω	
Maximum Capacitance (Input/Output)	10 pF	
Ambient Operating Temperature Range	–30 to +80 °C (derating applies)	–40 to +80 °C (derating applies)
Ambient Storage Temperature Range	–40 to +100 °C	
Weight (typical)	100 g (3.52 oz)	110 g (3.88 oz)
Input Indication	Green LED	
Encapsulation	Epoxy	
Terminals	1/4 in (6.35 mm); 3/16 in (4.74 mm)	Input: M3.5 Output: M4 (12 A), M6 (25/40 A)
Maximum Torque for Terminal Screws (screws dry without grease)	Input Terminals: 10 lb-in Output Terminals: 20 lb-in	
Safety Cover	Yes (IP20)	
Wire Clamp Plates	N/A	Yes
Agency Approvals	UL Recognized (File: E258297, CCN: NRNT2, NRNT8), CSA (File: 168986, Class: 3211-07), CE, RoHS	

Dimensions, Wiring Diagram, Derating Curves

Legacy Solid-State Relays

6000

SPST-NO, 10–75 A

DPST-NO, 10–25 A

Dimensions: in. (mm)

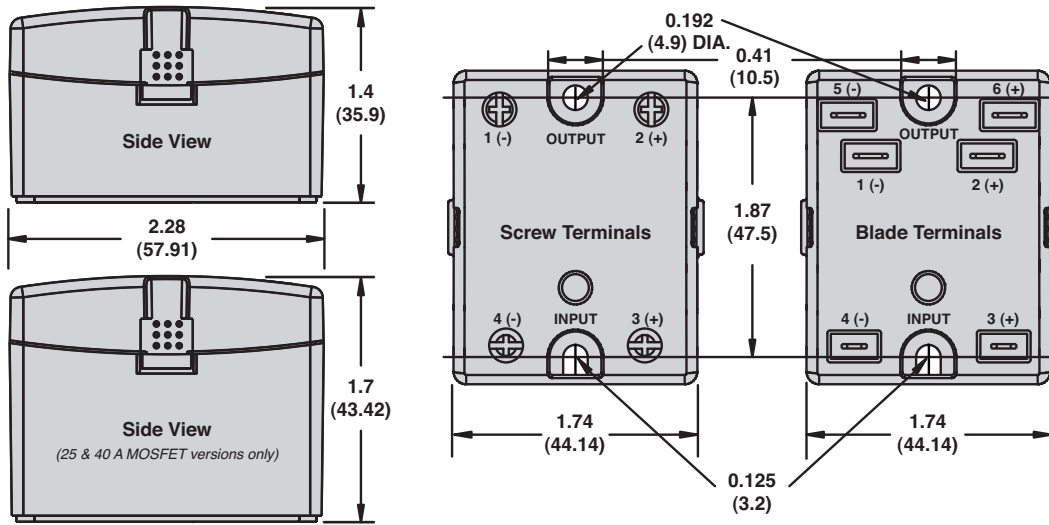

Wiring Diagram

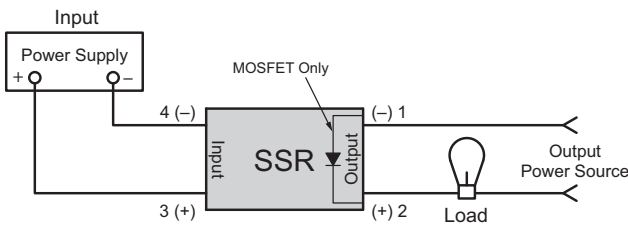

Terminal	Min.	Max.
Input	3.5 (0.138)	5 (0.197)
Output	4.2 (0.163)	6.35 (0.25)

OUTPUT	0–50 A	50–125 A
Cu 75 °C max. ambient 25 °C		

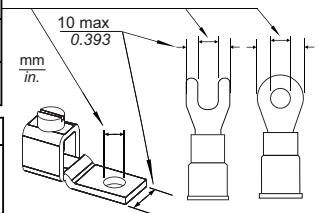

Derating Curves

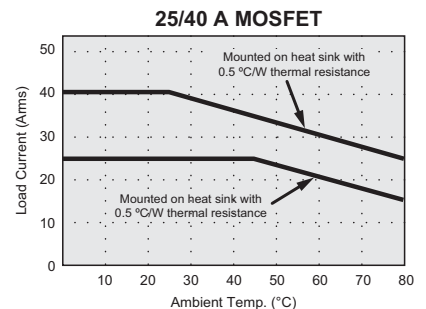
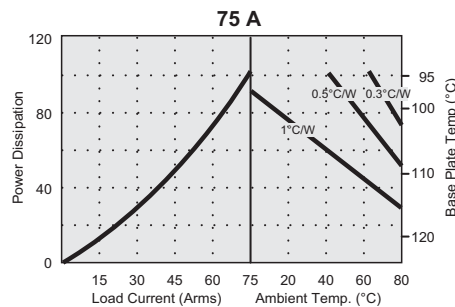
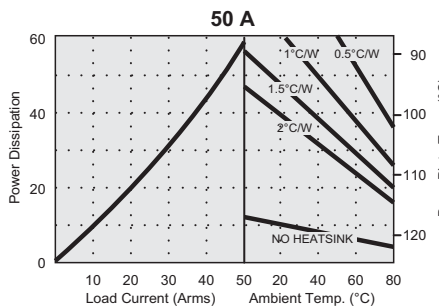
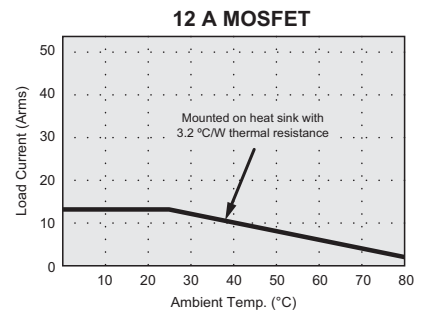
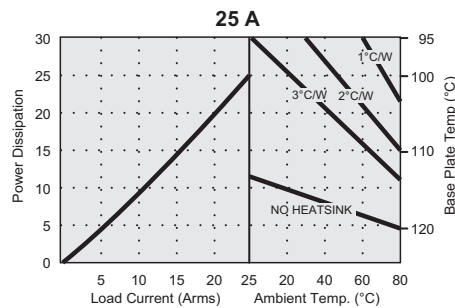
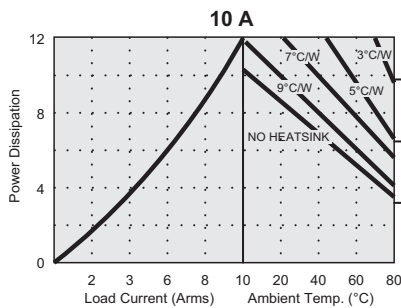

Description

Legacy Solid-State Relays

Accessories for 6000 Series

Heat Sink, SSR-HS-1

Thermal Pad, SSR-TP-1



SSR-HS-1



SSR-TP-1

Description

Thermal management is a fundamental consideration in the design and use of solid-state relays (SSRs) because of the contact dissipation (typically 1 W per ampere). It is vital to provide sufficient heat sinking, or the life and switching reliability of the SSR will be compromised.

The SSR-HS-1 heat sink maximizes heat dissipation and helps ensure reliable operation when properly selected for the specific application. For ease of installation, all mounting holes are pre-drilled and tapped.

The SSR-TP-1 simplifies installation with a simple peel-and-stick solution, which does not require messy thermal grease.

Relay Mounting Example

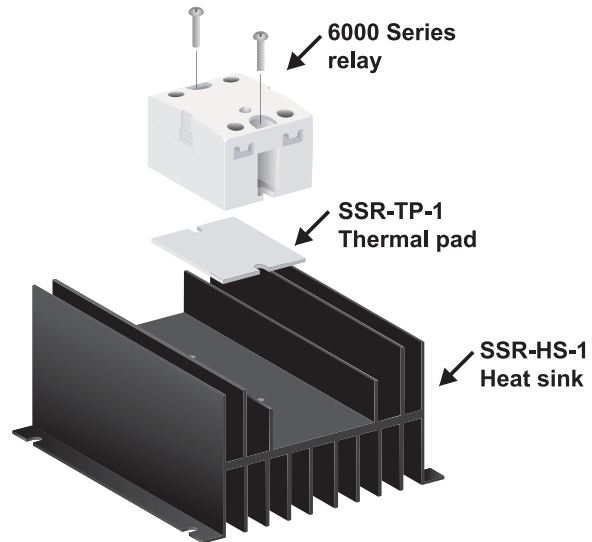

Description	Function	Weight	For Use With Relays	Packaging Minimum	Standard Part Number
Heat sink	Maximizes heat dissipation	558.5 g (19.7 oz)	6000 Series Relays (rated up to 50 A)	1	SSR-HS-1
Thermal pad	Simplifies installation with a peel-and-stick solution, which does not require messy thermal grease	N/A	6000 Series Relays (rated up to 50 A)	10	SSR-TP-1

Legacy Solid-State Relays

Accessories for 6000 Series

Heat Sink, SSR-HS-1

Thermal Pad, SSR-TP-1

Dimensions: in. (mm)

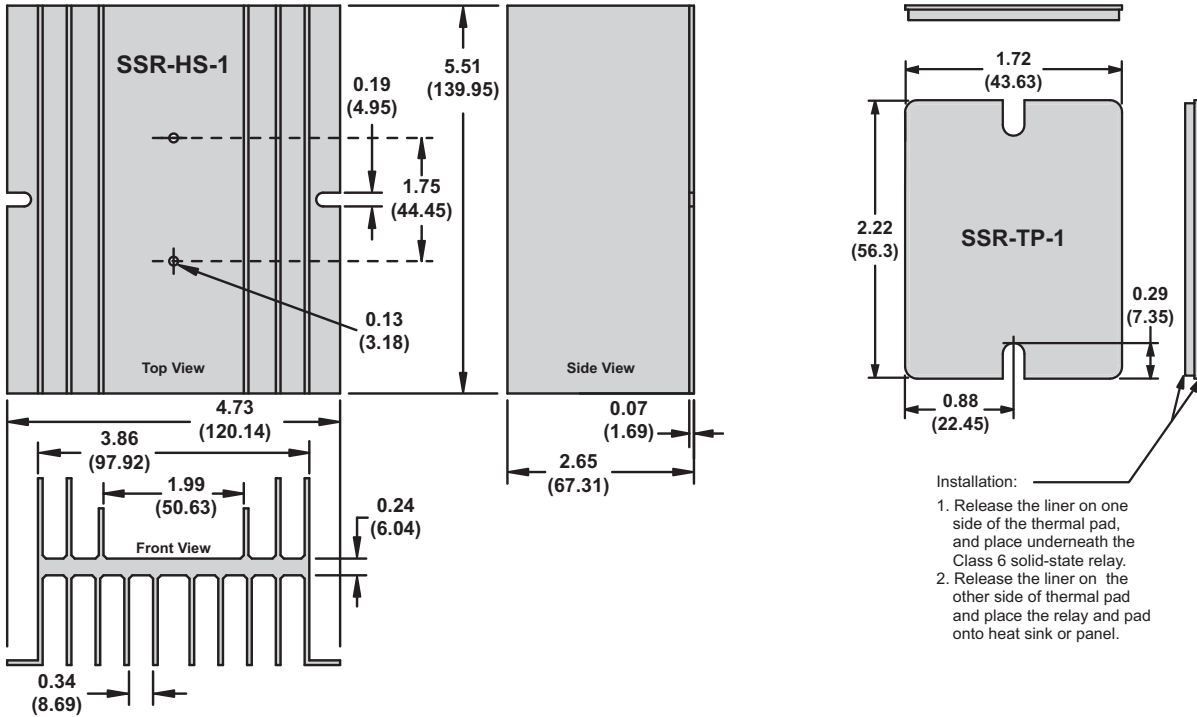

Derating Curves (when used with thermal pad and heat sink)

Thermal Resistance vs Power Dissipation

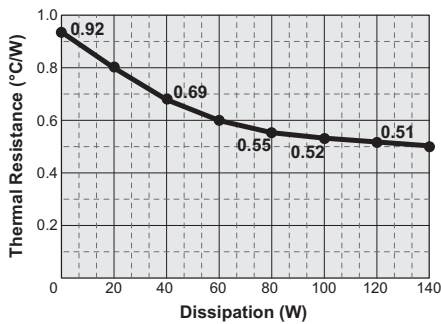

Load Current vs Ambient Temperature (100% Duty Cycle)

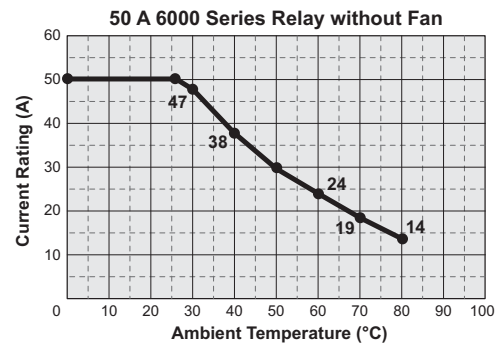
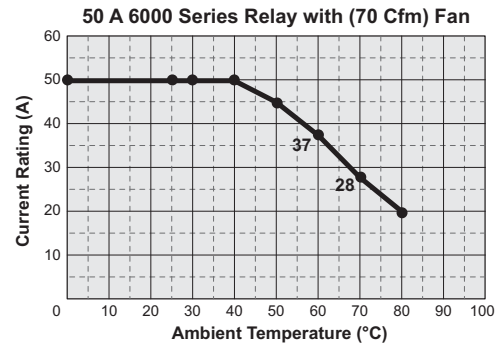

Description

Legacy Solid-State Relays

70S2
SPST-NO, 3–25 A



Description

The 70S2 Series are miniature solid-state relays ideal for small space applications. They are available in panel and PCB mount, which increases the level of flexibility for designers.

Feature	Benefit
Solid-state circuitry	Involves no moving parts
Optically coupled circuit	Provides isolation between input and output circuits
Internal snubber	Helps protect the relay's internal circuit from high voltage transients
Small package size	Ideal for small spaces
Panel and PCB mounting	Increases functionality and ease of use

Switching Type	Switching Device (1)	Input Voltage Range	Output Voltage Range	Rated Output Current (A)	Terminal Style	Mounting Style	Standard Part Number
DC Switching	MOSFET	3–15 Vdc	3–60 Vdc	3	Solder	PCB Mount	70S2-01-A-03-V
				5	Blade	Panel Mount	70S2-01-A-05-N
		9–30 Vdc	3–60 Vdc	5	Screw	Panel Mount	70S2-01-A-05-S
				4	Screw	Panel Mount	70S2-02-A-05-S
AC Zero Cross	TRIAC	3–30 Vdc	24–140 Vac	6	Solder	PCB Mount	70S2-04-B-04-F
				6	Blade	Panel Mount	70S2-04-B-06-N
				6	Screw	Panel Mount	70S2-04-B-06-S
			12	Blade	Panel Mount	70S2-04-B-12-N	
			12	Screw	Panel Mount	70S2-04-B-12-S	
			25	Screw	Panel Mount	70S2-03-B-25-S	
		24–280 Vac	6	Blade	Panel Mount	70S2-04-C-06-N	
			10	Solder	PCB/Panel Mount	70S2-04-C-10-M	
			12	Blade	Panel Mount	70S2-04-C-12-N	
			12	Screw	Panel Mount	70S2-04-C-12-S	
			12	Screw	Panel Mount	70S2-06-C-12-S	
			25	Screw	Panel Mount	70S2-03-C-25-S	
3–32 Vdc		24–140 Vac	24–280 Vac	3	Solder	PCB Mount	70S2-04-B-03-V
				3	Solder	PCB Mount	70S2-04-C-03-V
		8–50 Vac	24–280 Vac	3	Solder	PCB Mount	70S2-04-C-03-V
				3	Solder	PCB Mount	70S2-04-D-03-V
6–30 Vdc		24–280 Vac		12	Screw	Panel Mount	70S2-05-C-12-S

(1) See page 28 for definitions of the different switching devices.

Part Number Explanation

70S2 - 01 - A - 03 - V

Series:
70S2

Input Voltage:
01 = 3–15 Vdc
02 = 9–30 Vdc
03 = 3–30 Vdc
04 = 3–30 Vdc
05 = 6–30 Vdc
06 = 6–30 Vdc

Output Voltage:
A = 3–60 Vdc
B = 24–140 Vac
C = 24–280 Vac
D = 8–50 Vac

Output Current:
03 = 3 A
04 = 4 A
05 = 5 A
06 = 6 A
10 = 10 A
12 = 12 A
25 = 25 A

Package Type:

F = PCB Mount with Solder Terminals
M = PCB/Panel Mount with Solder Terminals
N = Panel Mount with Blade Terminals
S = Panel Mount with Screw Terminals
V = PCB Mount with Solder Terminals

Legacy Solid-State Relays

70S2

SPST-NO, 3–25 A

Specifications (UL 508)

Part Number	70S2-01-A	70S2-02-A	70S2-03-B	70S2-03-C
Input Characteristics				
Control Voltage Range	3–15 Vdc	9–30 Vdc	3–30 Vdc	
Must Release Voltage	1 Vdc			
Typical Input Current	5–40 mA	5–17 mA	7–16 mA	6–10 mA
Maximum Reverse Control Voltage	3 Vdc			
Output Characteristics				
Switching Device	MOSFET		TRIAC	
Switching Type	DC Switching		AC Zero Cross	
Contact Configuration	SPST-NO			
Output Voltage Range	3–60 Vdc		24–140 Vac	24–280 Vac
Peak Blocking Voltage	105 Vdc		400 Vac	600 Vac
Maximum Rate of Rise Off-State Voltage (dv/dt)	N/A		300 V/us	
Output Current Range (rms)	3–5 A	5 A	25 A	25 A
Minimum Load Current–Maintain On	N/A		100 mA	
Non-Repetitive Surge Current (8.3 ms)	3 A: 5 A (1 s); 5 A: 7 A (1 s)		300 A	
Maximum Off-State Leakage Current (rms)	10 mA		6 mA	
Typical On-State Voltage Drop (rms)	3 A: 1.2 Vdc; 5 A: 1.85 Vdc		1.7 Vac	
Maximum Turn-On Time	75 ms		8.3 ms	
Maximum Turn-Off Time	3 A: 500 ms; 5 A: 75 ms		8.3 ms	
General Characteristics				
Electrical Life	N/A for solid-state relays			
Thermal Resistance (Junction–Case)	3 A: 0.5 °C/W; 5/25 A: 4 °C/W			
Dielectric Strength (Input–Output)	3 A: 4000 Vac; 5 A: 2500 Vac		3000 Vac	
Dielectric Strength (Terminals–Chassis)	3 A: 4000 Vac; 5 A: 2500 Vac		3000 Vac	
Operating Temperature Range	–40 to +100 °C			
Storage Temperature Range	–40 to +125 °C			
Weight	F/M: 35 g (1.2 oz); N/S: 47 g (1.7 oz); V: 25 g (0.9oz)			
Agency Approvals	UL Recognized (E258297), CSA (040787), RoHS			

Specifications (UL 508)

Part Number	70S2-04-B	70S2-04-C	70S2-04-D	70S2-05-C	70S2-06-C
Input Characteristics					
Control Voltage Range	3 A: 3–32 Vdc; 4/6/10/12 A: 3–30 Vdc			6–30 Vdc	3–30 Vdc
Must Release Voltage	1 Vdc				
Typical Input Current	3 A: 1–19 mA; 4/6/10/12 A: 7–16 mA			6–10 mA	1–17 mA
Maximum Reverse Control Voltage	3 Vdc				
Output Characteristics					
Switching Device	TRIAC				
Switching Type	AC Zero Cross				
Contact Configuration	SPST-NO				
Output Voltage Range	24–140 Vac	24–280 Vac	8–50 Vac	24–280 Vac	
Peak Blocking Voltage	400 Vac	600 Vac	200 Vac	600 Vac	
Maximum Rate of Rise Off-State Voltage (dv/dt)	300 V/us				
Output Current Range (rms)	3–12 A	3–12 A	3 A	12 A	
Minimum Load Current–Maintain On	3/4/6 A: 75 mA; 10/12 A: 100 mA				
Non-Repetitive Surge Current (8.3 ms)	3/4/6 A: 60 A; 10/12 A: 150 A				
Maximum Off-State Leakage Current (rms)	6 mA		10 mA	6 mA	
Typical On-State Voltage Drop (rms)	1.6 Vac				
Maximum Turn-On Time	8.3 ms				
Maximum Turn-Off Time	8.3 ms				
General Characteristics					
Electrical Life	N/A for solid-state relays				
Thermal Resistance (Junction–Case)	3 A: 0.5 °C/W ; 4/6/10/12 A: 4 °C/W				2.4 °C/W
Dielectric Strength (Input–Output)	3 A: 4000 Vac; 4/6/10/12 A: 3000 Vac				
Dielectric Strength (Terminals–Chassis)	3 A: 4000 Vac; 4/6/10/12 A: 3000 Vac				
Operating Temperature Range	–40 to +100 °C (derating applies)				
Storage Temperature Range	–40 to +125 °C				
Weight	F/M: 35 g (1.2 oz); N/S: 47 g (1.7 oz); V: 25 g (0.9 oz);				
Agency Approvals	UL Recognized (E258297); CSA (040787); RoHS				

Dimensions: in. (mm)

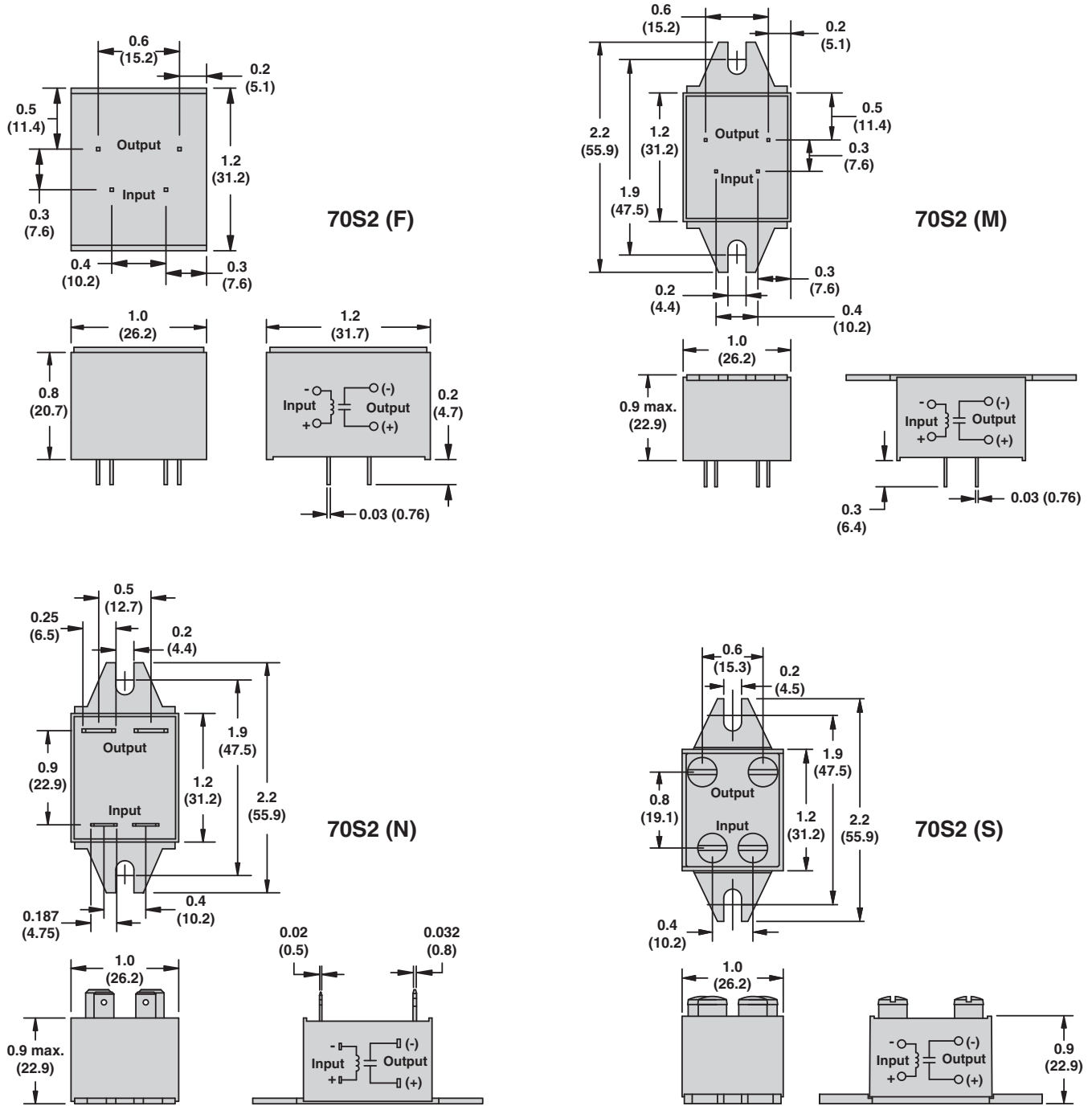

Dimensions: in. (mm)

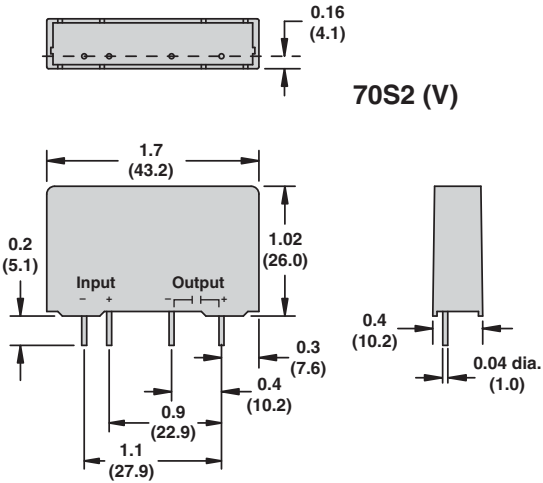

Wiring Diagram

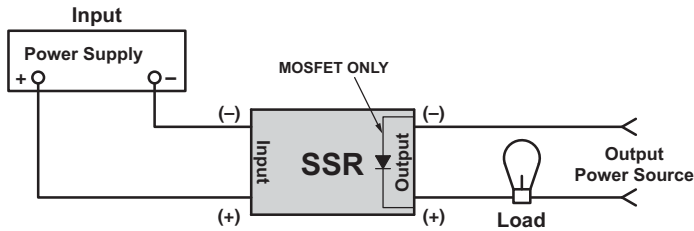

Derating Curves

Load Current vs Ambient Temperature (100% Duty Cycle)

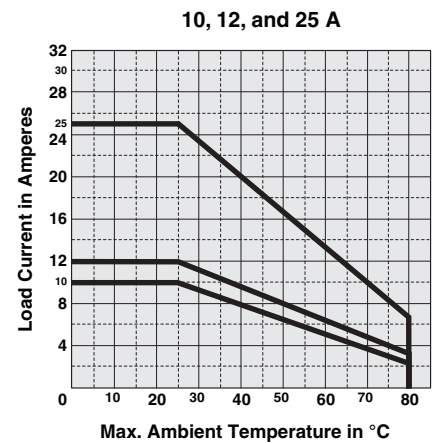
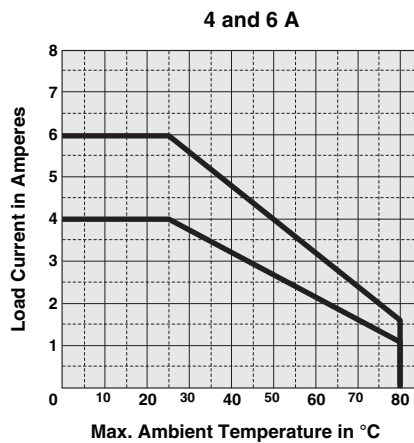
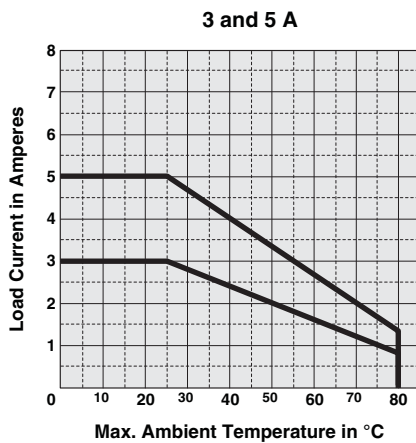

Definition

A solid-state relay (SSR) can perform many tasks that an electromechanical relay (EMR) can perform. The SSR differs in that it has no moving mechanical parts. It is essentially an electronic device that relies on the electrical and optical properties of semiconductors to achieve its isolation and switching function.

Principle of Operation

SSRs are similar to electromechanical relays, in that both use a control circuit and a separate circuit for switching the load. When voltage is applied to the input of the SSR, the relay is energized by a light emitting diode. The light from the diode is beamed into a light-sensitive semiconductor, which conditions the control circuit to turn on the output solid-state switch. In the case of zero-voltage crossover relays, the output solid-state switch is turned on at the zero crossing of AC voltage. Removal of input power disables the control circuit, and the solid-state switch also turns off when the load current passes through the zero point of its cycle. Zero cross only applies to AC switching circuits. DC switching circuits operate at an instant on/off rate.

Advantages

When used correctly in the intended application, the SSR provides many of the characteristics that are often difficult to find in the EMR. A high degree of reliability, long service life, significantly reduced electromagnetic interference, fast response, and high vibration resistance are significant benefits of the SSR. The SSR has no moving parts to wear out, or arcing contacts to deteriorate, which are often the primary cause of failure with an EMR.

- Long life (reliability) > 1E+9 operations
- Zero voltage turn-on, low EMI/RFI
- Resistance to shock and vibration
- Random turn-on, proportional control
- No contact bounce
- Arc-less switching
- No acoustical noise
- TTL compatibility
- Fast response
- No moving parts

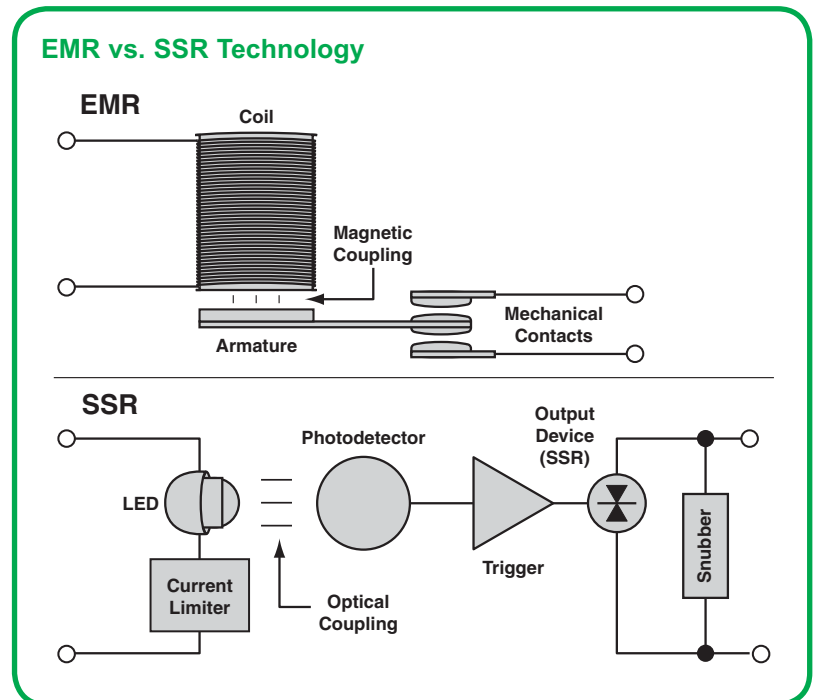

Applications

Since its introduction, SSR technology has gained acceptance in many applications that had previously been the sole domain of the EMR or contactor. The major growth areas have come from industrial process control applications—particularly heat/cool temperature control, motors, lamps, solenoids, valves, and transformers. The list of applications for the SSR is almost limitless.

Typical Examples of SSR Applications



Electronic Appliances

Domestic appliances, cooking appliances, heating elements, audio equipment



Industrial Heater Control

Plastics industry: drying, extrusion/thermoforming, heat tracing, solder wave/reflow systems, car wash pumps and dryers



Food and Beverage

Commercial/industrial cooking equipment, filtration systems, bottling, chillers, convection ovens



Lighting Control

Traffic signal systems, highway information systems, theatrical lighting



High Reliability

Medical equipment, elevators and escalators, automatic door operation (low switching noise, low electromagnetic interference)



Mining

Blower control, motorized duct/vent control, drill control, explosive control, mineral extractors



HVAC and Refrigeration

Anti-condensation equipment, compressor control, blower control, motorized duct/vent control



Oil and Gas

Burner assemblies, chemical injection systems, extraction machines, refining machines, solenoid control



Industrial Appliances

Industrial cleaning equipment, commercial coffee machines, commercial/industrial cooking equipment



Packaging

Conveyor motors, heaters, product/shrink wrap, solenoid control



Industrial Automation

Automotive assembly plants, conveyance, motor control

Using A Temperature Derating Curve

In the example below, a temperature derating curve for a 50 A, Class 6 solid-state relay is used to determine the maximum allowable load current at an ambient temperature of 70 °C. A heat sink with a 2 °C/W temperature coefficient is used in the application.

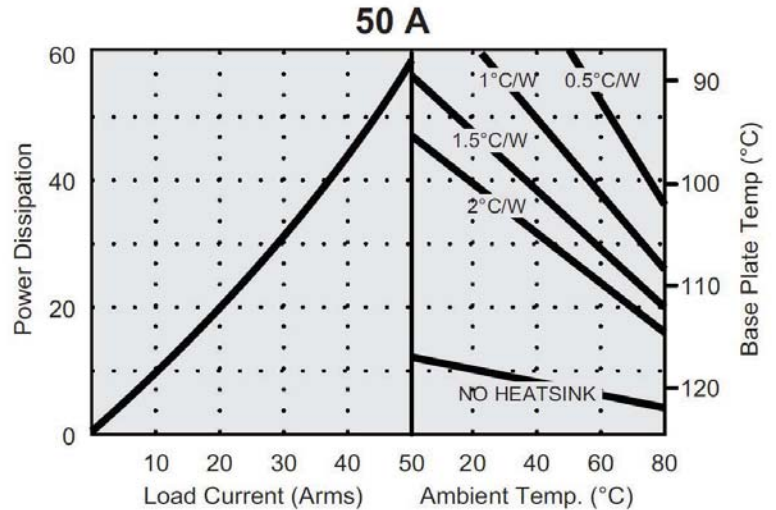

From the right half of the graphic, the point at which the heat sink coefficient curve crosses 70 °C is translated to the left half of the graphic until it intersects the power dissipation vs load current curve of the 50 A, Class 6 relay as shown in the illustration below:

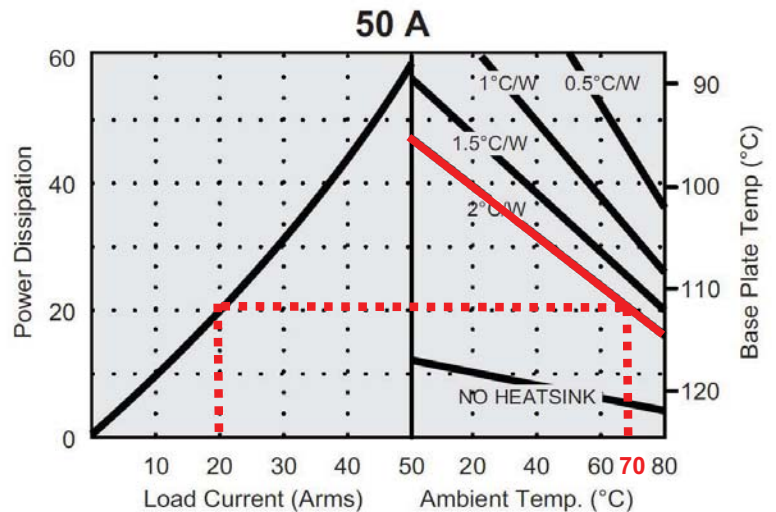

The result is that a maximum load current of 20 Arms is recommended when using a 50 A, Class 6000 relay in an ambient temperature of 70 °C when using a heat sink with a 2 °C/W temperature coefficient.

Load Considerations

After improper heat sinking, the next most significant cause of application problems with SSRs stems from the operating conditions that specific loads impose on an SSR. Carefully consider the surge characteristics of the load when designing an SSR as a switching solution.

• Resistive Loads

A load with a constant value of resistance is the simplest application of an SSR. Proper thermal consideration, along with attention to the steady-state current ratings, is important for reliable operation.

• DC Loads

DC loads are inductive loads. Place a diode across the load to absorb surges during turn-off.

• Lamp Loads

Incandescent lamp loads, though basically resistive, require special consideration. Because the resistance of the cold filament is about 5–10% of the heated value, a large inrush current can occur. It is essential to verify that this inrush current is within the surge specifications of the SSR. Also ensure that the lamp rating of the SSR is not exceeded. This UL rating is based on the inrush of a typical lamp. Due to the unusually low filament resistance at the time of turn-on, a zero voltage turn-on characteristic is particularly desirable with incandescent lamps.

• Capacitive Loads

These types of loads can be difficult because of their initial appearance as short circuits. High surge currents can occur while charging, limited only by circuit resistance. Use caution with low impedance capacitive loads to verify that the dI/dt capabilities are not exceeded. Zero voltage turn-on is a particularly valuable means of limiting dI/dt with capacitive loads.

• Motors and Solenoids

Motor and solenoid loads require special attention for reliable SSR functionality. Solenoids have high initial surge currents because their stationary impedance is very low. Motors can also have severe inrush currents during starting and can impose unusually high voltages during turn-off. As a motor's rotor rotates, it creates a back-EMF (electromotive force) that reduces the flow of current. This back-EMF can add to the applied line voltage and create an overvoltage condition during turn-off. Likewise, consideration must be given to mechanical loads having high starting torque or inertia, such as fans and flywheels, to verify that the inrush currents are within the surge capabilities of the SSR. Use a current shunt and oscilloscope to examine the duration of the inrush current.

Transformers

When switching transformers, consider the characteristics of the secondary load. These characteristics reflect the effective load on the SSR. In addition, voltage transients from secondary load circuits can act as transformers and impose on the SSR.

Transformers present a special challenge: Depending on the transformer flux state at turn-off, the transformer may saturate during the first half-cycle when voltage is next applied. This saturation can impose a very large current (10–100 times the rated typical current) on the SSR, which far exceeds its half-cycle surge rating. SSRs with random turn-on may have a better chance of survival than a zero-cross turn-on device, since they commonly require the transformer to support only a portion of the first half-cycle of the voltage. On the other hand, a random turn-on device will frequently close at the zero-cross point, and then the SSR must sustain the worst-case saturation current. A zero-cross turn-on device has the advantage that it turns on in a known mode and will immediately demonstrate the worst case condition. The use of a current shunt and an oscilloscope is recommended to verify that the half-cycle surge capability is not exceeded.

As a general rule, when applying an SSR to a transformer load, select an SSR having a half-cycle current surge rating greater than the following:

$$(\text{maximum applied line voltage}) \div (\text{transformer primary resistance})$$

The primary resistance is usually easy to measure and can be relied on as a minimum impedance limiting the first half-cycle of inrush current. The presence of some residual flux, plus the saturated reactance of the primary, will then further limit, in the worst case, the half-cycle surge safely within the surge rating of the SSR.

Switching Devices

The power family of semiconductors consists of several switching devices. The most widely used of this family are metal-oxide semiconductor field-effect transistors (MOSFETs), silicon controlled rectifiers (SCRs), TRIAC, and Alternistor TRIAC. In many applications, these devices perform key functions, so you must understand their advantages as well as their shortcomings to properly design a reliable system. Applied correctly, SSRs are an asset in meeting environmental, speed, and reliability specifications which their electromechanical counterparts could not fulfill.

• MOSFET

A power MOSFET is a specific type of metal-oxide semiconductor field-effect transistor (MOSFET) designed to handle large amounts of power. It is a vertical-structured transistor capable of sustaining high blocking voltage and high current. Power MOSFETs are used in DC switching applications. Care must be taken to ensure proper polarity for all DC ports. Failure to do so can lead to permanent device damage.

• TRIAC

A TRIAC is an electronic component approximately equivalent to two silicon-controlled rectifiers joined in inverse parallel (paralleled but with the polarity reversed) and with their gates connected together. This results in a bidirectional electronic switch that can conduct AC current only. The TRIAC is ideal for switching non-reactive loads.

• Alternistor TRIAC

The Alternistor is specifically designed for applications that switch highly inductive AC loads. A special chip offers performance similar to two SCRs wired in inverse parallel (back-to-back), providing better turn-off behavior than a standard TRIAC. The Alternistor TRIAC is an economical solution, ideal for switching inductive AC loads.

• SCR

The SCR (silicon-controlled rectifier) acts as a switch, conducting when its gate receives a current pulse, and continuing to conduct as long as it is forward biased. The SCR is ideal for switching all types of AC loads.

Legacy Schneider Electric Solid-State Relays

Legacy Schneider Electric solid-state relays offer a number of advantages over electromechanical relays, including longer life cycles, less energy consumption, and reduced maintenance costs, depending on the application.

Selecting a Solid-State Relay

The list below is an example of the specifications to look for when selecting a solid-state relay.

Class I, Division 2 certification (y/n): _____

Input voltage: _____

Output voltage: _____

Load rating: _____

Contact configuration: _____

Ambient temperature: _____

In-rush currents: _____

Mounting style: _____

Use the catalog specifications or online parametric search to determine a recommended part number (www.serelays.com).

More About Class I, Division 2 Certified Products

Class I, Division 2 is a classification which was developed by the American National Standards Institute (ANSI) to provide requirements for the design and construction of electrical equipment and parts that will be used in hazardous locations. Certified components, when used properly, are not capable of igniting the surrounding atmosphere.

Class I, Division 2 components may be required in environments which may contain specific flammable gases, combustible dust, or fibers that can ignite. The 861H SSR carries a Class I, Division 2 (Categories A, B, C, D and Temperature code T5) approval from Underwriters Laboratories.



The Schneider Electric Relays website (www.serelays.com) allows users to easily find the proper relay to fit design requirements and to help simplify and shorten workflow.

Easily find the proper relay to fit design requirements

■ Online Catalog

Find the right product by choosing specifications, compare products side-by-side, and view technical specifications, 2D and 3D drawings, and associated accessories.

■ Cross Reference Search

Search our comprehensive database to identify products by manufacturer and part number, and link directly to part specifications.

■ 3D CAD Library

View, email, download, or insert a file directly into your open CAD software pane, and select from 18 different file formats.

■ Order Free Samples

Schneider Electric offers free samples as a courtesy to individuals and companies evaluating our products in their designs and applications. Sample orders are subject to approval.

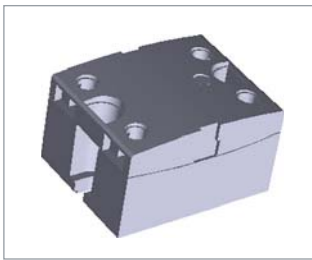

3D Models

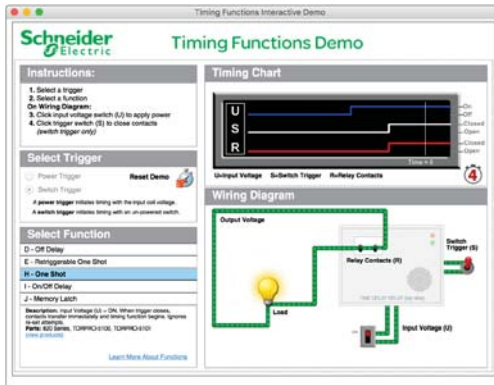

Time Delay Relay Demo

Simplify and shorten workflow

■ Interactive Tools

View interactive demonstrations such as our Time Delay Relay Interactive Demo (left) which visually demonstrates the ten different timing functions offered on Schneider Electric time delay relays.

■ Distributor Inventory Search

Search authorized distributors' current Schneider Electric inventory and buy online. (Buying online is not available for all distributors.)

70S2	3, 19–23	861SSR115-DD	4	SSR245DIN-AC45	10
70S2-01-A	20	861SSR208-DD	4	SSR245DIN-DC45	10
70S2-01-A-03-V	19	861SSR210-AC-1	4	SSR310DIN-DC22	10
70S2-01-A-05-N	19	861SSR210-AC-2	4	SSR320DIN-DC22	10
70S2-01-A-05-S	19	861SSR210-DC-1	4	SSR330DIN-DC22	10
70S2-02-A	20	861SSR210-DC-2	4	SSR610DIN-AC22	10
70S2-02-A-05-S	19	861SSR210-DC-4	4	SSR610DIN-DC22	10
70S2-03-B	20	861SSR410-AC-1	4	SSR620DIN-AC22	10
70S2-03-B-25-S	19	861SSR410-AC-2	4	SSR620DIN-DC22	10
70S2-03-C	20	861SSR410-DC-1	4	SSR630DIN-AC22	10
70S2-03-C-25-S	19	861SSR410-DC-2	4	SSR630DIN-DC22	10
70S2-04-B	21	861SSR610-AC-1	4	SSR645DIN-AC45	10
70S2-04-B-03-V	19	861SSR610-AC-2	4	SSR645DIN-DC45	10
70S2-04-B-04-F	19	861SSR610-DC-1	4	SSR665DIN-AC45	10
70S2-04-B-06-N	19	861SSR610-DC-2	4	SSRDIN	3, 10–12
70S2-04-B-06-S	19	861SSRA	5	SSR-HS-1	17, 18
70S2-04-B-12-N	19	861SSRA208-AC-1	4	SSR-TP-1	17, 18
70S2-04-B-12-S	19	861SSRA208-AC-2	4		
70S2-04-C	21	861SSRA208-DC-1	4		
70S2-04-C-03-V	19	861SSRA208-DC-2	4		
70S2-04-C-06-N	19	861SSRA208-DC-4	4		
70S2-04-C-06-S	19	861SSRA408-AC-1	4		
70S2-04-C-10-M	19	861SSRA408-AC-2	4		
70S2-04-C-12-N	19	861SSRA408-DC-1	4		
70S2-04-C-12-S	19	861SSRA408-DC-2	4		
70S2-04-D	21	6000	3, 13–18		
70S2-04-D-03-V	19	6210AXXSZS-AC90	13, 14		
70S2-05-C	21	6210AXXSZS-DC3	13, 14		
70S2-05-C-12-S	19	6210BXXTZB-DC3	13, 15		
70S2-06-C	21	6225AXXSZS-AC90	13, 14		
70S2-06-C-12-S	19	6225AXXSZS-DC3	13, 14		
861	3, 4–6	6240AXXSZS-AC90	13, 14		
861H	3, 7–9	6240AXXSZS-DC3	13, 14		
861HSSR	8	6250AXXSZS-AC90	13, 14		
861HSSR115-DD	7	6250AXXSZS-DC3	13, 14		
861HSSR208-DD	7	6275AXXSZS-AC90	13, 14		
861HSSR210-AC-1	7	6275AXXSZS-DC3	13, 14		
861HSSR210-AC-2	7	6312AXXMDS-DC3	13, 15		
861HSSR210-DC-1	7	6325AXXMDS-DC3	13, 15		
861HSSR210-DC-2	7	6340AXXMDS-DC3	13, 15		
861HSSR210-DC-4	7	6410AXXSZS-AC90	13, 14		
861HSSR410-AC-1	7	6425AXXSZS-AC90	13, 14		
861HSSR410-AC-2	7	6425AXXSZS-DC3	13, 14		
861HSSR410-DC-1	7	6425AXXTZB-DC3	13, 15		
861HSSR410-DC-2	7	6425BXXTZB-DC3	13, 15		
861HSSR610-AC-1	7	6440AXXSZS-AC90	13, 14		
861HSSR610-AC-2	7	6440AXXSZS-DC3	13, 14		
861HSSR610-DC-1	7	6450AXXSZS-AC90	13, 14		
861HSSR610-DC-2	7	6450AXXSZS-DC3	13, 14		
861HSSRA	8	6475AXXSZS-AC90	13, 14		
861HSSRA208-AC-1	7	6475AXXSZS-DC3	13, 14		
861HSSRA208-AC-2	7	SSR2	11		
861HSSRA208-DC-1	7	SSR3	11		
861HSSRA208-DC-2	7	SSR6	11		
861HSSRA208-DC-4	7	SSR210DIN-AC22	10		
861HSSRA408-AC-1	7	SSR210DIN-DC22	10		
861HSSRA408-AC-2	7	SSR220DIN-AC22	10		
861HSSRA408-DC-1	7	SSR220DIN-DC22	10		
861HSSRA408-DC-2	7	SSR230DIN-AC22	10		
861SSR	5, 8	SSR230DIN-DC22	10		

Schneider Electric USA, Inc.

www.serelays.com

200 N. Martingale Road
Schaumburg, IL 60173
Tel: 847-441-2540

The information and dimensions in this catalog are provided for the convenience of our customers. While this information is believed to be accurate, Schneider Electric reserves the right to make updates and changes without prior notification and assumes no liability for any errors or omissions.

Schneider Electric is a trademark and the property of Schneider Electric SE, its subsidiaries and affiliated companies. All other trademarks are the property of their respective owners.

8501CT1002R02/17 © 2010–2017 Schneider Electric. All Rights Reserved
Replaces 8501CT1002R07/11 dated 10/2011
06/2017